

VICIOUS CIRCULAR BREATHING

BY RAFAEL LOZANO-HEMMER



TABLE OF CONTENTS

GENERAL IMPORTANT INFORMATION

Technique	3
Description	3
Operation	3
Maintenance	4
Placement Instructions	5

DETAILED TECHNICAL INFORMATION

Normal Software Operation	19
Remote Access to Artwork's Computer	21
Preliminary Troubleshooting Steps	22
Troubleshooting Assistance	26
Support (Contact Us)	27

APPENDIX I - INSTALLATION

Description of Components	28
Wiring Diagrams and Connections	36
Close-Up Photos	39
Procedure to Install and Hang the Bags and the Air Hoses	42

GENERAL IMPORTANT INFORMATION

This short section must be read for proper operation.

VICIOUS CIRCULAR BREATHING (2013)

BY RAFAEL LOZANO-HEMMER

Technique

Sealed glass prism with an automatic sliding door system, motorized bellows, electromagnetic valve manifold, 61 brown paper bags, custom circuitry, respiration tubing, sensors, computer.

Description

Vicious Circular Breathing is a hermetically-sealed apparatus that invites the public to breathe the air that was previously breathed by participants before them. Initially commissioned by Borusan Contemporary in Istanbul, the installation consists of a glass room with double sliding doors, two emergency exits, carbon dioxide and oxygen sensors, a set of motorized bellows, an electromagnetic valve system, and 61 brown paper bags hanging from respiration tubes. In the piece, visitors' breath is kept circulating and made tangible by automatically inflating and deflating the brown paper bags around 10,000 times a day, the normal respiratory frequency for an adult at rest. There are 61 bags because that constitutes five octaves, a typical range of musical organs which inspire the design. The piece includes warnings for asphyxiation, contagion and panic, and produces a faint mechanical sound, a quiet whirl from the air flow and a louder crackle from the crumpling bags. To participate, an audience member presses a button on the outside of the glass prism. They can then enter a vestibule and wait for it to be decompressed. Once they enter the main chamber, they sit down and breathe the recycled air.

Please walk around the valve table, bellows and glass chamber, do not walk in between them in order to prevent tripping on cables and air hoses.

Operation

Please refer to [Appendix I - Installation](#) for a description of the components and wiring diagrams.

Important Note: Only supply the glass chamber with 120 Volt AC, not 240 VAC! The bellow power supplies need to be manually switched to work with 120VAC or 240VAC.

The power to the glass room, the bellows, and the valve table is controlled by a power strip with a built-in timer. The timer is set to cut the power at midnight (12:00 AM) and turn on again at 8:00 AM. The MacBook Air under bellow #2 is not connected to this timer. In system preferences, we set the computer to shutdown at 12:15 AM and to restart at 8:15 AM.

1. Connect the computer, the Kinect, the motor driver, and the projector to electrical power. Use the supplied power cables.

2. Depending on the version of the artwork you have, you might find a small black box on which to connect a power cable. On that box, you will also find a button that is used to turn the artwork ON/OFF.

If your version does not have this box, you will either use the computer's power button to turn the artwork ON/OFF, or you can set the computer to an automatic power schedule.

3. To turn the piece ON, press the computer's power button for one second, then release it. Important: Please do not push the button again as this will shut down the piece. Wait at least two minutes before pressing it again as the computer might take this long to boot. After two minutes (or less), you should see activity from the piece.

To turn the piece OFF, press the power button on the side of the small box or using the computer button.

Wait about 60 seconds until everything including the projector is finished its shutdown routine. The projector is ready to be used again once the lens door is closed, or the indicator LEDs on the projector indicates that the cool down process is done.

4. If the piece does not start within two minutes, try turning on the piece again. If it still doesn't turn on, then hold the power button all the way down for 10 seconds. Then, wait at least three seconds and press the power button all the way down for one second, and you should be up and running again.

Maintenance

Please clean the glass room with regular glass cleaner to remove smudges, fingerprints or stains. Remove any dust that might have accumulated on top of the glass room.

If the button boxes on the glass room are not straight or are loose, please tighten or straighten them.

All other plastic parts on the artwork should be cleaned with non-abrasive cleaners.

Remove any dust on top of the bellow's Plexiglass covers, the valve table, and the big Plexiglass tubes on the tables.

If dark particles collect between the bellow and the motor towers (such as those shown in the images below), please remove them.

Ensure that all the plastic hose connections are in place and have not slipped apart from the glass room, under the bellows, from the big Plexiglass tubes on the valve table, or from the 61 small air valves.



Dust on glass ceiling



Abrasion dust from belt drive

Placement Instructions

Please consult the following diagram, paying particular attention to the measurements and the numbered bellows.



The piece should be centered between the left and right walls, with the cluster of paper bags facing the entrance of the room.

The entrance to the glass chamber should face the back wall. Leave enough space to comfortably have people line up there (at least 250 cm).

The space in front of the cluster of paper bags should be larger than the space behind the glass chamber.

Only one power cable should enter the whole installation. We usually drop a white power cable from the ceiling on to the glass room, centred in the entrance.

Layout of Assembly:

The paper bags are individually suspended using thin fishing wire. Usually, a metal grid is mounted to the ceiling, allowing for a natural distribution of the hanging points. The bags are not hung all at the same height, and the air hoses are not all hung evenly.

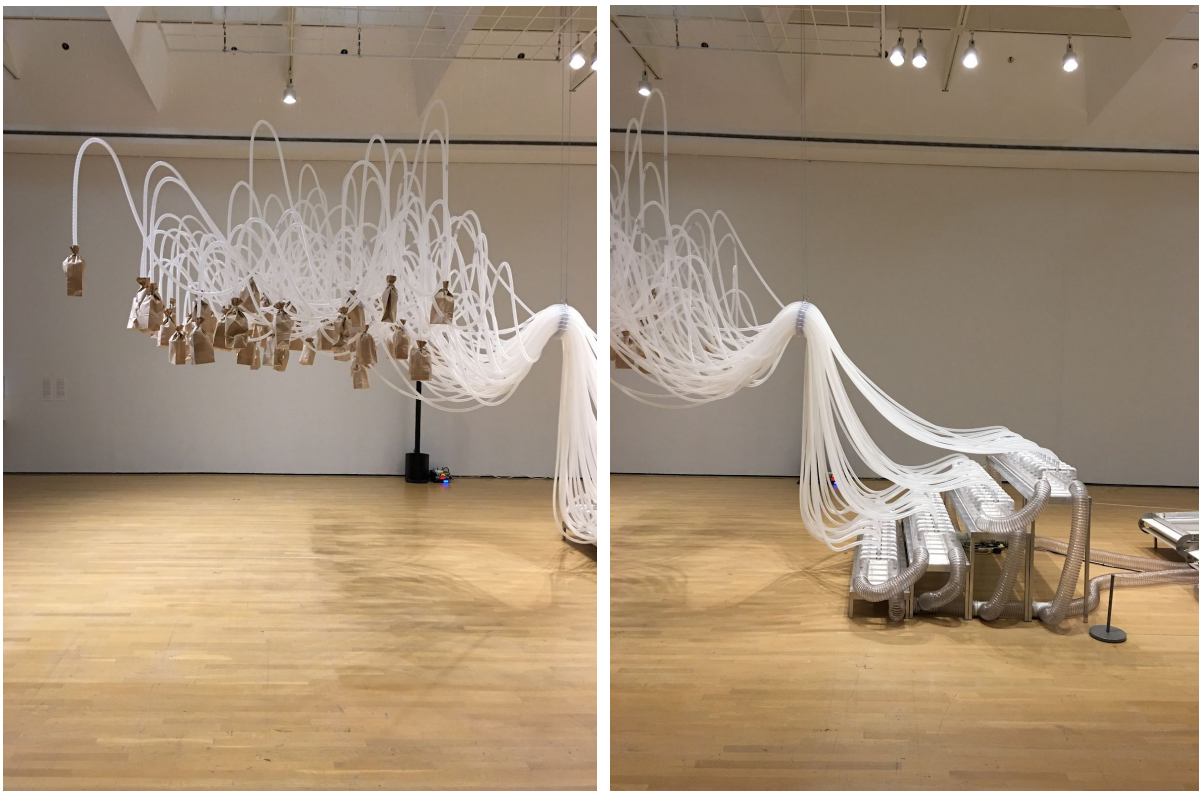

The air hoses from the valve table are connected to a manifold disc. The top table valves go to the top of the disc, while the bottom valve hoses go to the bottom of the ring. This produces the cleanest looking connection. The disc is suspended from two steel wires. Please ensure that the disc remains hung as vertically as possible.

There are four valve tables, each with two big plexiglass tubes atop them. One tube carries the vacuum and the other carries the positive pressure. It is important to ensure that the correct PCV duct hose connects to the correct Plexiglass tube.

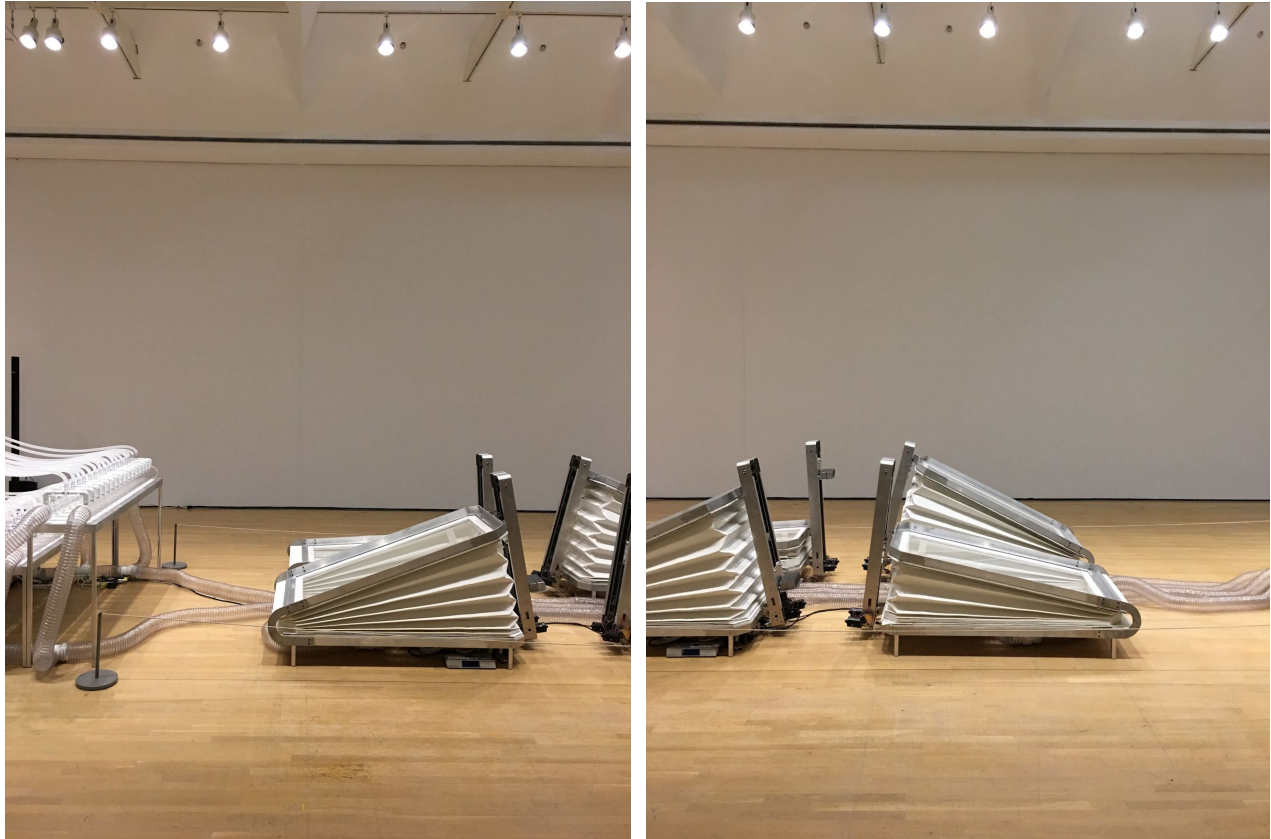

The artwork has four bellows: the two closest to the valve table are generating the vacuum while the other two generate the positive pressure. Since it is harder to produce a negative pressure (vacuum), the belt drive is outfitted with extra weights. These weights are secured to the carrier with double-sided tape. Consult [the Appendix](#).

The following items are hidden under bellow #0 (see above placement plan for numbering of bellows): a MacBook computer, a wifi router, a power bar, mechanical power timers, an Arduino mega, and an Enttect DMX USB interface. Each bellow also has a 24VDC power supply and a DC motor driver hidden underneath it.

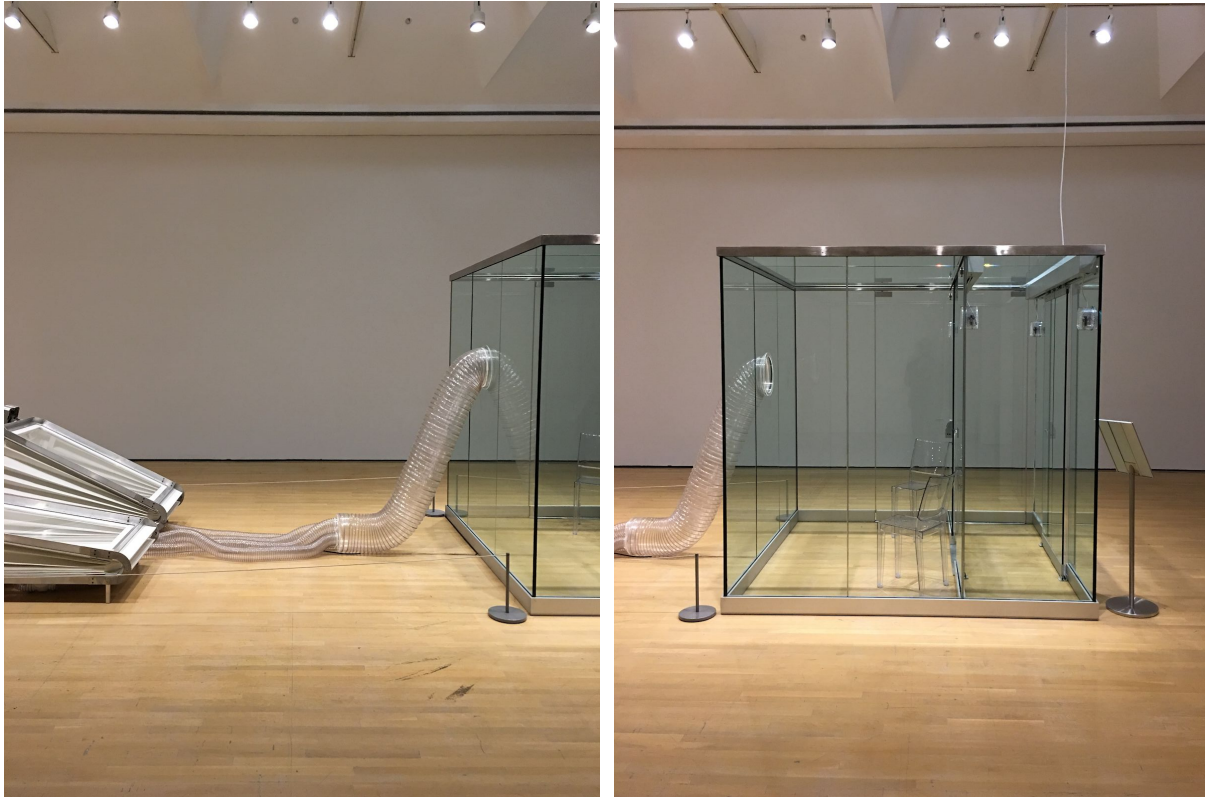

The glass chamber is assembled from multiple sheets of glass, which are held in place by a bottom and top metal frame. The corners of the four glass sheets are also glued together with black structural silicone. The gaps between the glass sheets are sealed with TODO proper plastic name or an easily-removable silicon.

Layout of PVC Duct Hose:

Please consult the images on the following pages related to the layout of the PVC Duct hose.

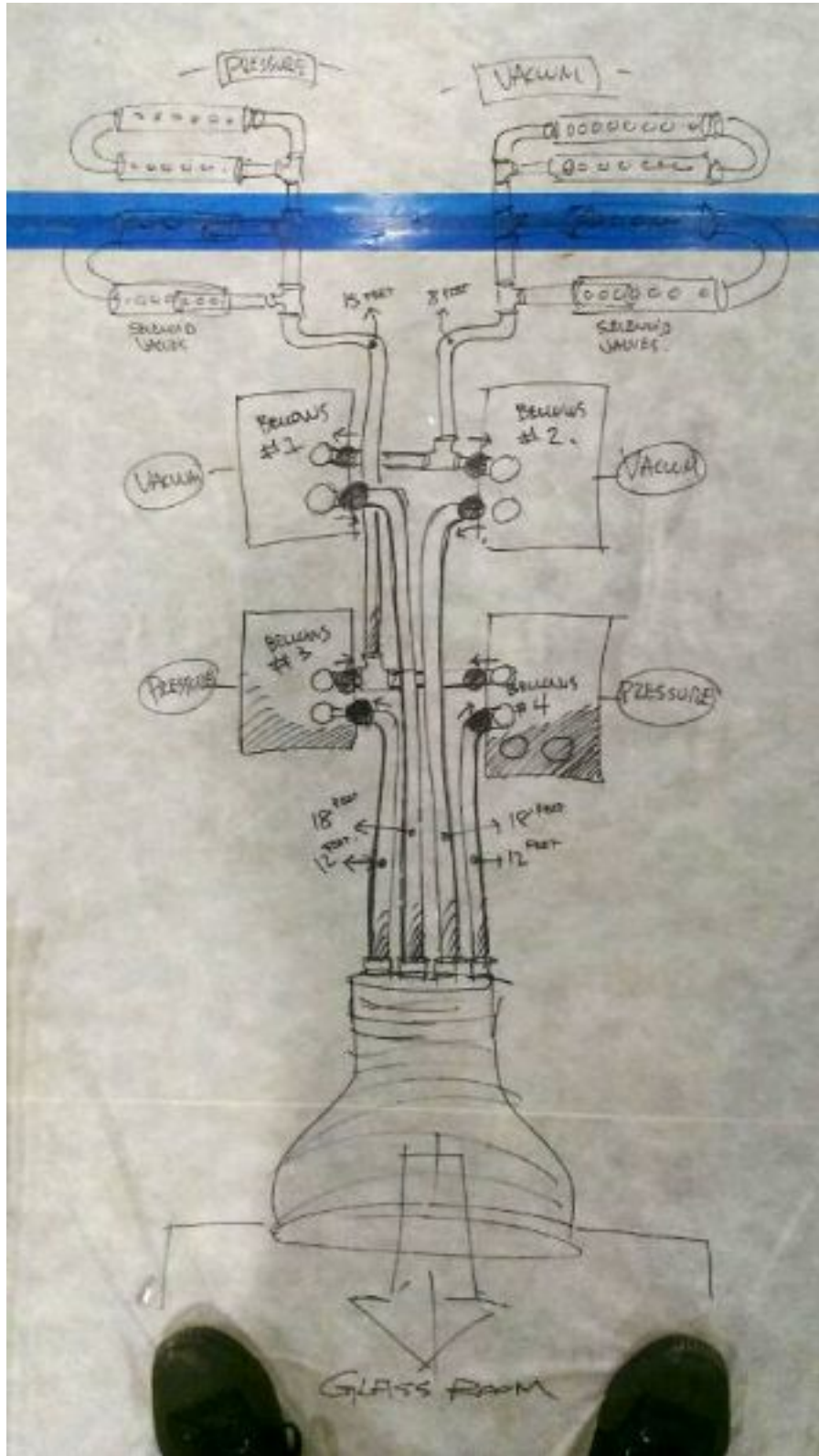

Sketch of the layout of the PVC Duct hose

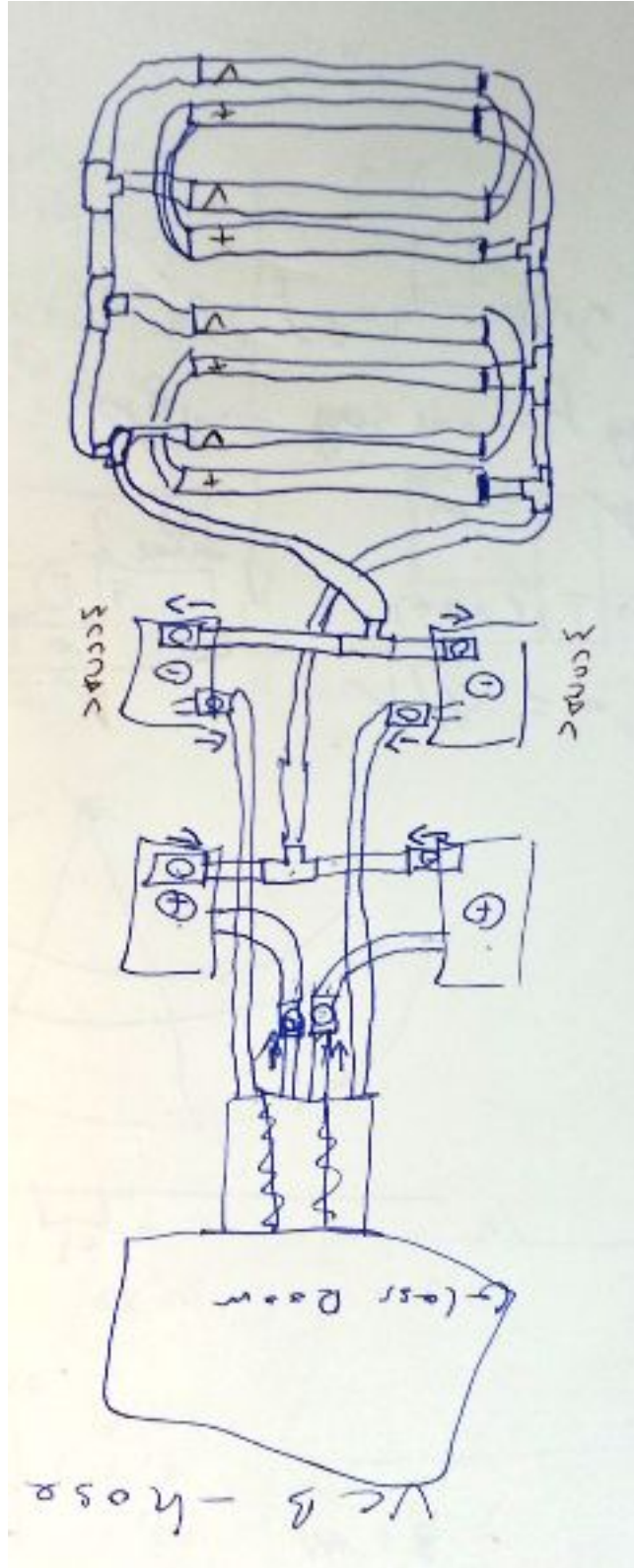

Sketch of the layout of the PVC Duct hose

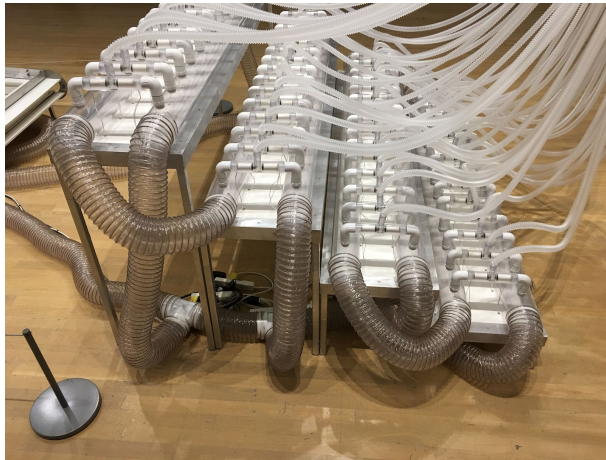

Valve table, left side

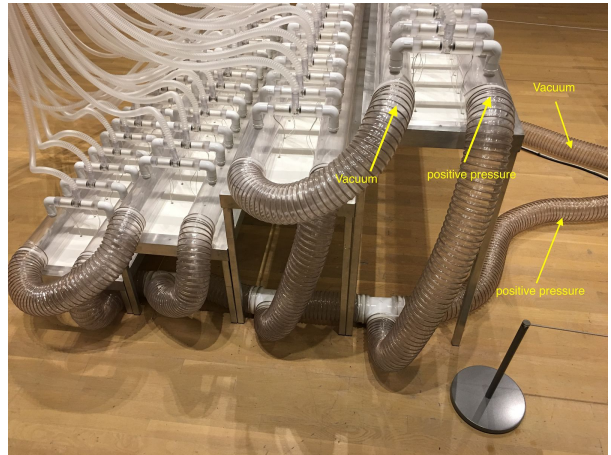

Valve table, right side

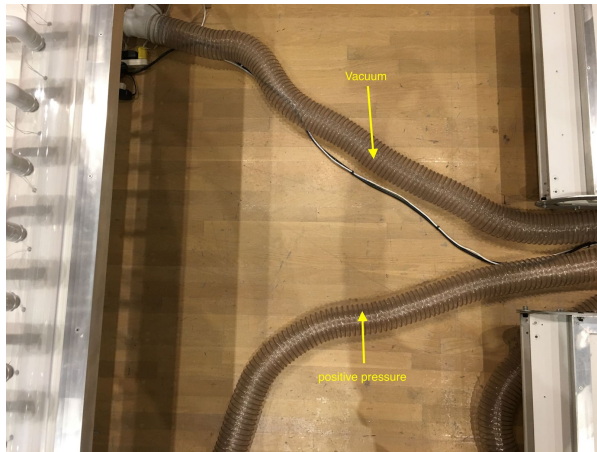

Air flow from bellows to valve table

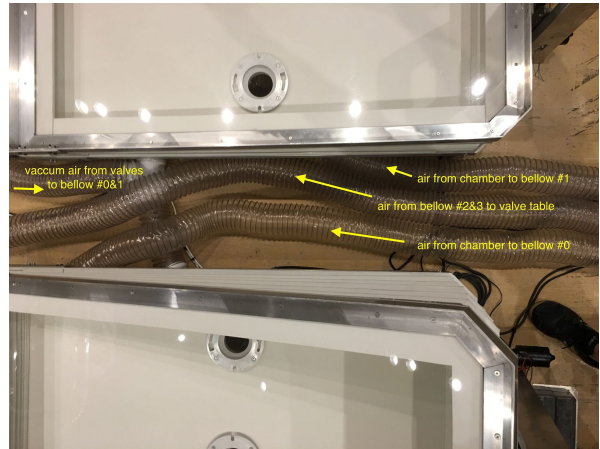

Directions of the air flow

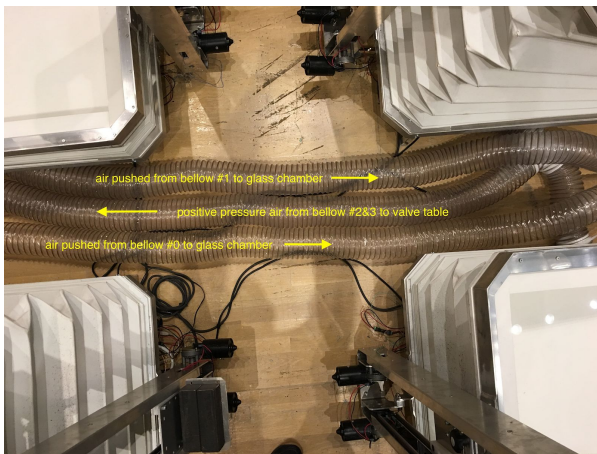

Directions of the air flow

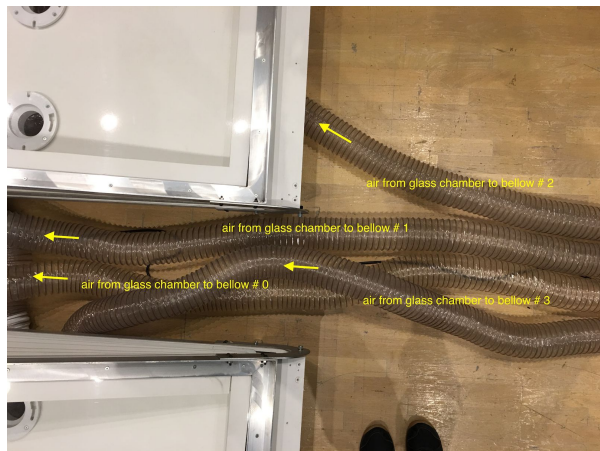

Air flow from glass chamber to bellows

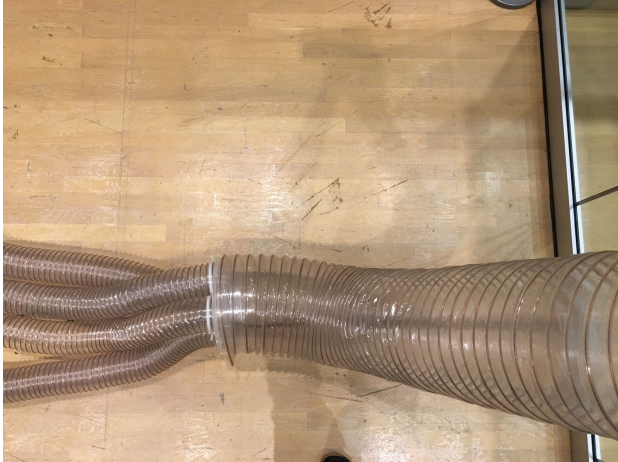

Each bellow has two flow valves located at the back; they are big white plastic devices that sit right under the bellows. The valves attach to the opening/closing of the bellow through a short piece of PCV duct hose.

These back flow valves need to sit upright otherwise the internal flow flap does not work properly and air would leak out. In the photo, you'll notice that we used foam to prevent the valves from flipping onto their sides.

Placement of Power Cables:

As mentioned previously, only supply the glass chamber with 120 Volt AC, **NOT** 240 VAC! The bellow power supplies need to be manually switched to work with 120 VAC or 240 VAC.

Only one power cable is seen entering the assembly, at the back of the glass chamber, positioned in the centre of the sliding door entrance. From there, it runs along the metal frame, entering the second sliding door box. A junction splits the power, and a black power cable runs to the glass wall between the two emergency exit doors. The cable should be glued to the side of the glass wall so that it fits right between the two closed doors. Once on the ground, the power cable runs along the foundation of the glass chamber to the front, in the centre. Hidden by floor-colored tape or a cover, the cable will then run beneath the flexible PVC duct hose towards where the four bellows meet. There, a power bar separates the bellows and valve table from the power supply of the computer and the wifi router. The valve tables and the bellows are on a mechanical timer, which turns the devices on and off according to museum's schedule.

The computer and wifi router will always receive power. The computer has an internal power scheduler which turns it on and off.

See [Appendix](#) for wiring diagram.



Power cable centered above glass chamber entrance



Power cable going to the inside of the second sliding door track. From there, it moves downwards, between the emergency doors



Black power cable running between the floor frame and the two emergency doors



Power and data cables running under the hose to the valve table

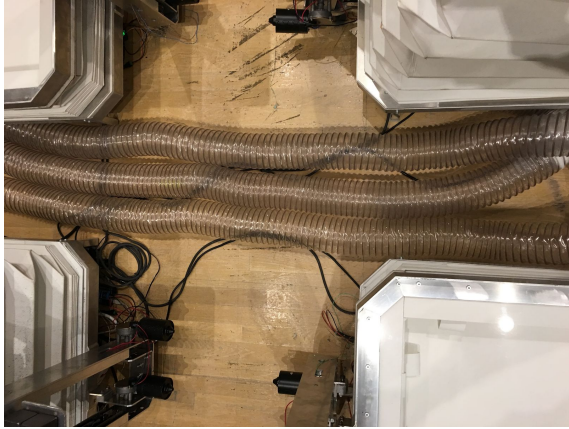

Power cables between four bellows, each splitting power their respective bellow



Power and data cables running under the hose to the valve table

Wiring, Glass Chamber:



Wiring, Valve Table:

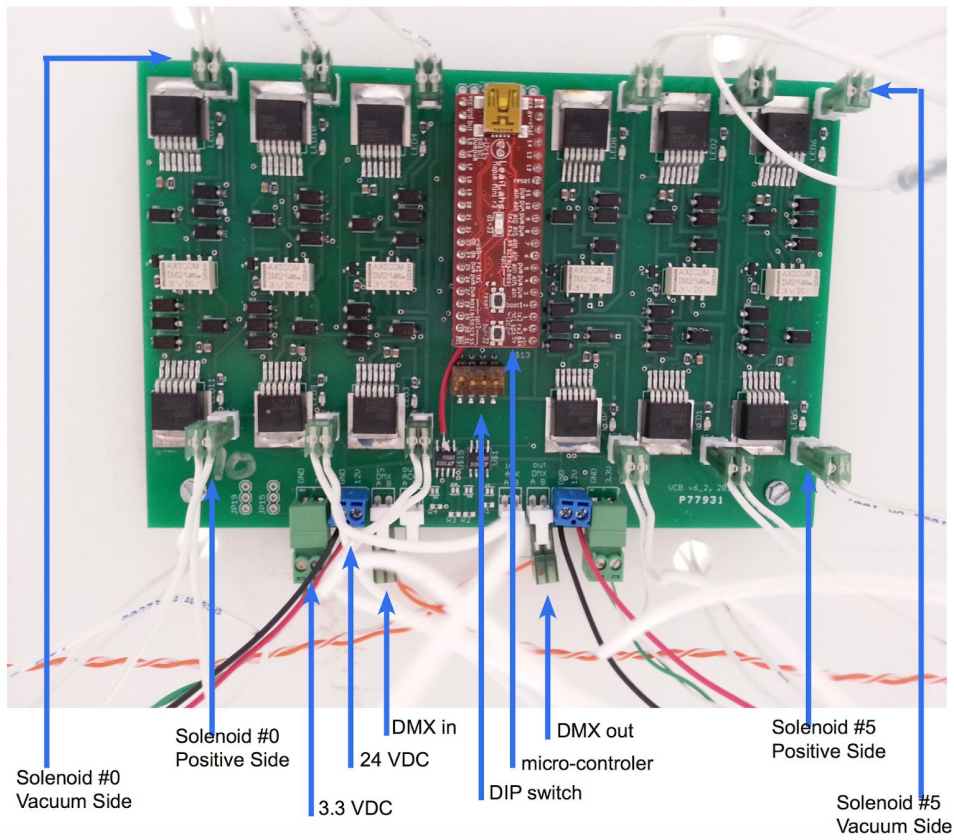
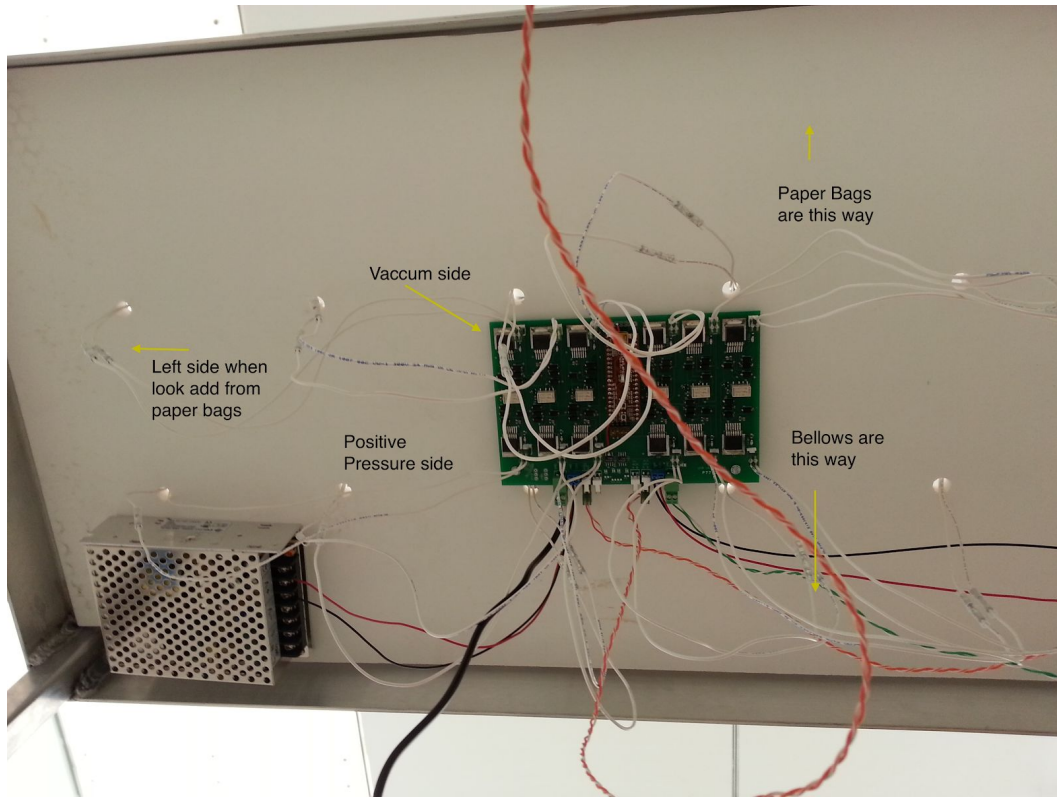

Wiring, Bellows:

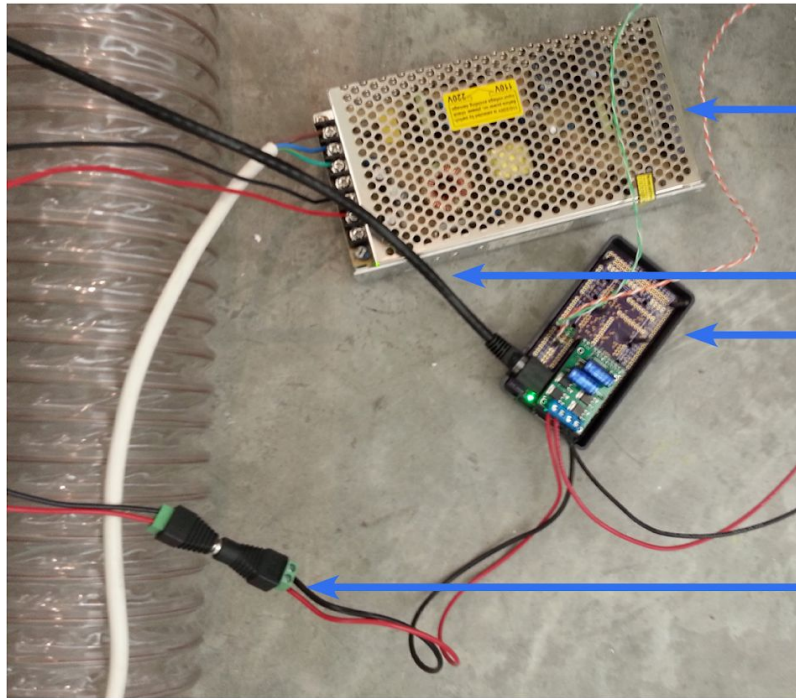

120/240 VDC to 12VDC power supply

data cable going to Arduino

motor driver

12 VDC main power plug

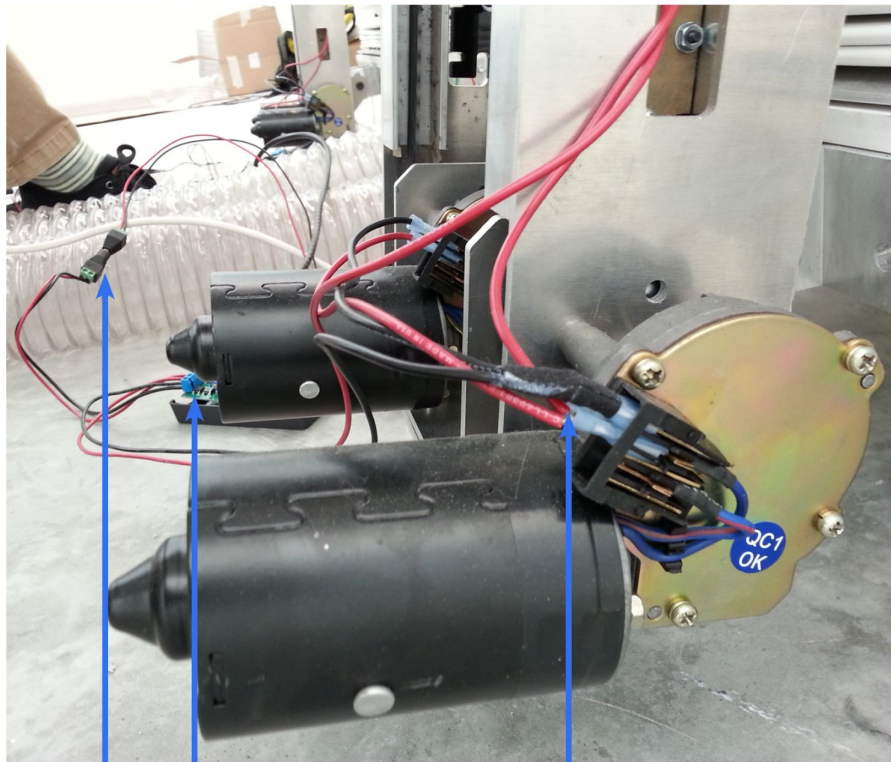

Motor driver
12 VDC main motor plug

12 VDC coming from safety switches

Wiring, Bellows continued:

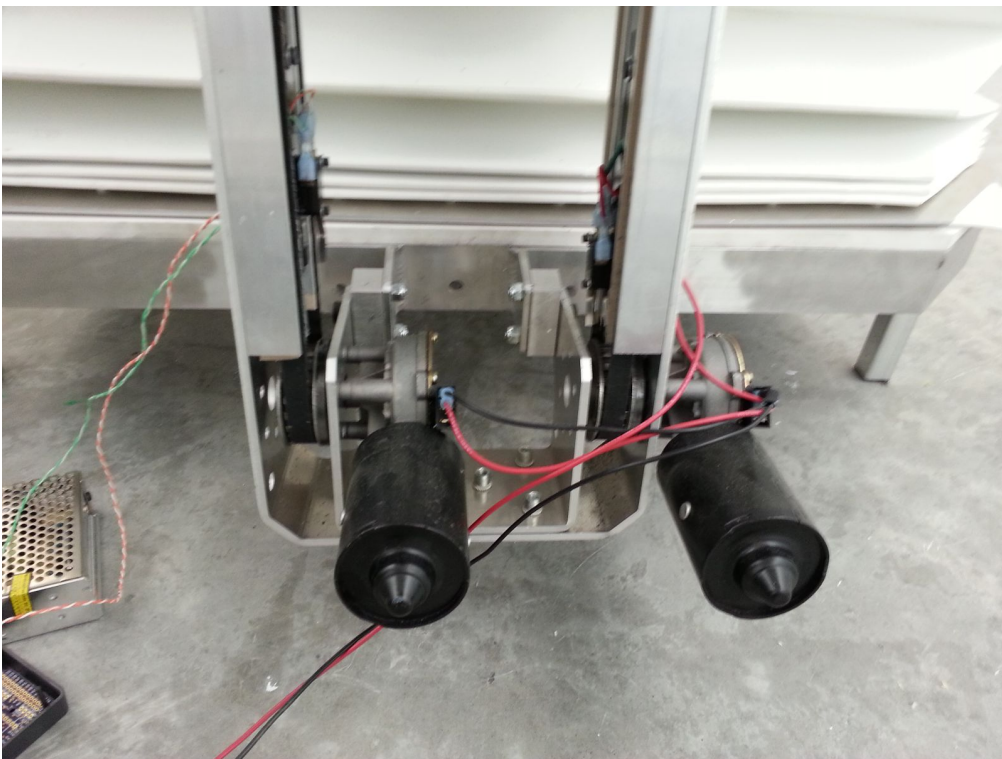
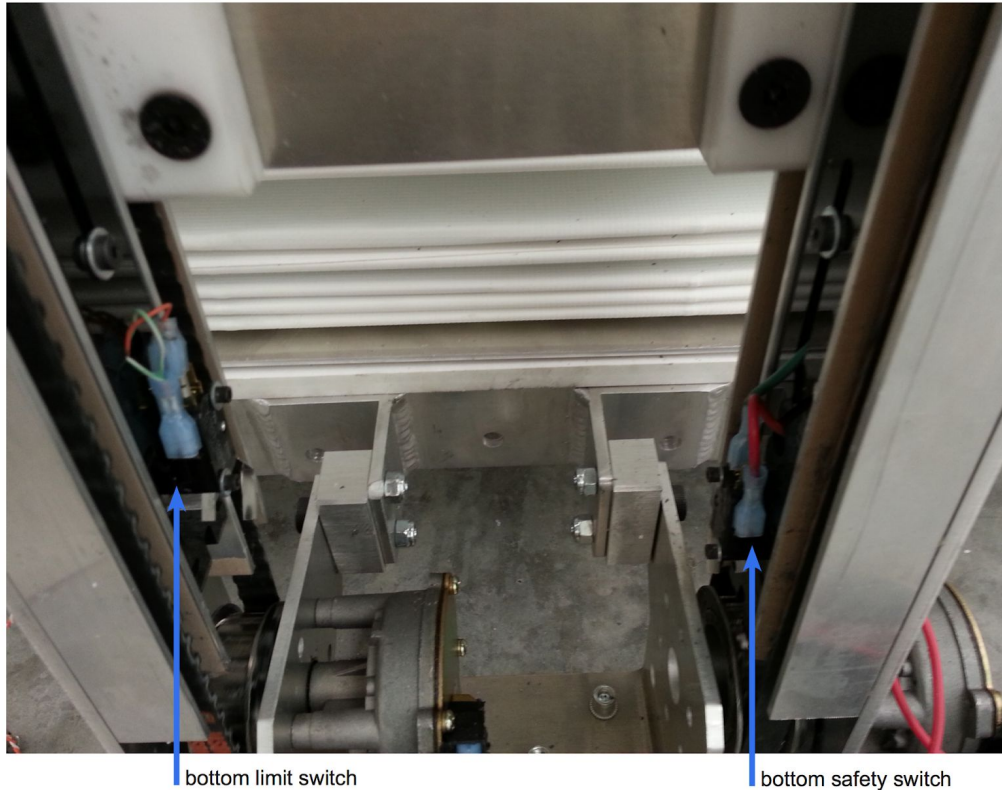

DETAILED TECHNICAL INFORMATION

Normal Software Operation

The software starts up automatically after booting is done, or when clicking on the VCB app in the dock.

Glass Chamber Signal Logic:

1. Button or Touch Display are pressed by visitor.
2. The Button or Touch Display sends the touch signal to the Arduino.
3. The Arduino signals the display to change its image informing visitors to enter and wait five seconds.
4. The Arduino signals the Motor Driver to open one set of sliding doors.
5. The Button Box uses its proximity sensor to check if a visitor is still in between the sliding doors. This is a safety measure to prevent people from getting hurt by the doors.
6. Once the visitor is not blocking the door, the Arduino waits for five seconds and then signals the Motor Driver to close the doors.
7. At the top of each set of sliding doors is a limit switch. Once a set of sliding doors is shut, it engages the limit switch.
8. Once the limit switch is pressed, the Arduino signals the AC relay to power the AC Fans associated with this specific set of sliding doors.
9. After eight seconds, the Fans stop and the Arduino signals the other set of sliding doors to open.
10. The other set of sliding doors stay open so long as the visitor is blocking the proximity sensor inside the other button box.

As an additional safety measure, it is possible to push the button on any button box at any time in order to open a set of sliding doors.

Bellow Signal Logic:

1. When the software on the MacBook Air first starts, it sends a start signal to the bellow Arduino. This happens about 20 seconds after the software has started running.
2. The two vacuum bellows alternate their up-and-down motion. While one bellow is creating a vacuum to suck air out of the paper bags, the second bellow deflates in order to be ready for when the first bellow exhausts its capacity to create a vacuum.
3. The same happens for the positive pressure bellows.
4. The up-and-down motions of the vacuum bellows are not timed to the behaviour of the positive pressure bellows.
5. Each bellow has limit switches which are located on the left, inside the actuator track. They have thinner wires connected to them. These switches tell the Arduino when the bellow reaches the top or the bottom. In return, the Arduino tells the motor driver to reverse the motor's motion.
6. Each bellow also has a set of safety switches which are located closer to the absolute limits of the belt drive. If the limit switches do not work and the motor does not reverse

direct, then the safety switches might activate. If this happens, the safety switch directly cuts the 12VDC power to the motors. You will need to manually move the bellow actuators back until the safety switch is not engaged anymore.

Valve Signal Logic:

1. The software on the MacBook Air constantly sends DMX control signals to the valve solenoid drivers.
2. Each valve is held in the vacuum or positive pressure position for 10-30 seconds, then flips to the other side.

Remote Access to Artwork's Computer

There is a software installed on the computer running this artwork that allows the studio to connect remotely to the artwork. This feature is helpful when you require assistance from the studio, as we can remotely connect to it, do a quick inspection, and do a debugging session of your components, if needed. In order to enable this feature, the computer has to be connected to the internet at all times. Depending on the computer's operating system (Windows 7/8/10, OSX), the procedure to set the computer online will vary. Please look online for tutorials, if necessary.

Preliminary Troubleshooting Steps

COMPUTER:

Bellows and valve tables are not moving.

Under bellow #0, a MacBook Air has an OSX software running.

After computer is done booting, the software starts automatically. The software tells the valves to start moving and, after 20 seconds of waiting, will also tell the bellows to start moving.

You should see the following image on the screen when the app is running.

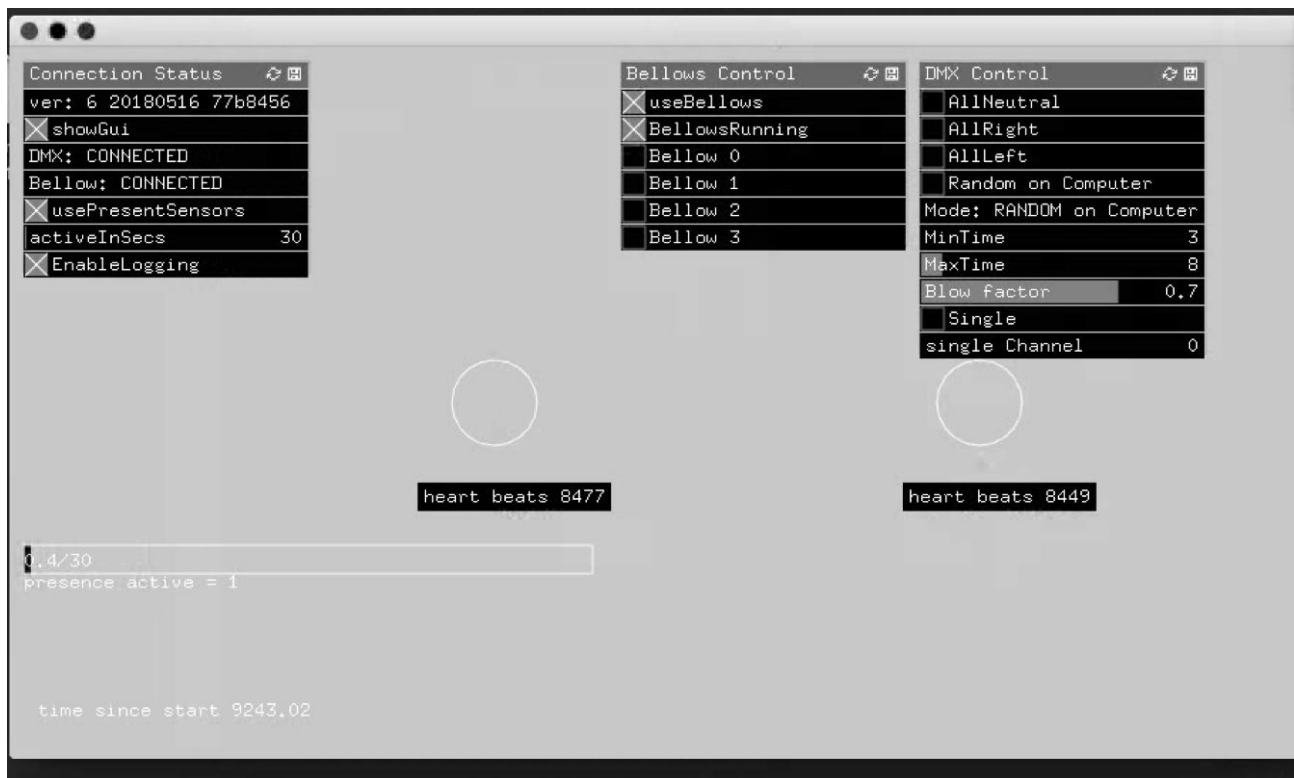

It might also be that the Enttec USB DMX adaptor and the bellow Arduino Mega are plugged in to the wrong USB ports.

GLASS CHAMBER:

Only supply the glass chamber with 120 Volt AC, NOT 240 VAC!

The glass room has three main elements: the two button boxes, the limit switches in the middle of the glass doors, and an Arduino mega that acts as the brain. All three elements need to work together for the room to function properly.

The doors do not open.

It might be that either the button box does not recognize the button push, or the Arduino is having problems, or the limit switch between the glass doors did not get pushed.

1. Check that the displays in the button box are changing their text every few seconds. If not, and the display is either black or the text does not change, then cycle the power to the whole glass room.
2. The doors might not be touching the little black limit switch at the top, where the two sliding parts of the doors are meeting. When this button is not being pushed, the system does not know that the doors are closed and does not progress.
3. Open the metal box at the top left of the outer sliding door. Inside the box, you see the Arduino. It needs to have power to work. It has multiple LEDs on it to indicate if it is working.

BELLOWS:

The bellow power supplies need to be manually switch to work with 120VAC or 240VAC!

The bellows are comprised of the following elements: eight motors, one Arduino, four motor drivers, and eight limit switches.

Each bellow has multiple limit switches that are triggered when the bellow reaches its top or bottom position. In fact, each bellow has four limit switches: two to communicate the top and bottom position to the Arduino under bellow #0, and the other two switches are for safety and will cut the motor power if the bellow goes too high or too low. If this happens, you will need to manually move the bellow until these switches are not engaged anymore.

The bellows work in alternating modes. This means that when one bellow is actively sucking or blowing air to the paper bags, the other one is either resting or moving to its default position.

If one of the bellows gets stuck and never hit its limit switches, the other bellow might never get the signal to move. Therefore, please inspect the limit switches.

The bellows are controlled by one Arduino mega, which is located under bellow #0, inside a

grey box. From this Arduino, we have 3 Cat5 cables going to the other three bellows. The other three bellows also have a PCB (Printed Circuit Board) inside a grey box. But these boxes only house the motor driver for their respective bellow.

Make sure all the wires are connected to the motors and drivers and did not get loose.

Each bellow has two motors which move the bellows up and down via a v-belt system. It is possible for the belts to get too loose. This means that the motor's force is not being applied evenly across both belts. You might need to tighten the belt gear at the top of each motor actuator. You will be able to tell that the force is not being applied evenly when the metal plate that attaches the actuator to the bellow is not remaining horizontal throughout its movement.

It can also happen that one of the two motors stops working. Sometimes, the internal motor gear breaks; while the motor is still spinning, it will not cause its output shaft to rotate. Please replace the motor with the supplied spare.

VALVE TABLE:

The valve table is composed of the following elements: 12 solenoid driver controllers, four 24VDC power supplies, four 3.3VDC power supplies, and lots of solenoid air valves.

Each of the four valve tables has three solenoid controllers. Each controller gets 24VDC and 3.3VDC power through two different power supplies.

The power is daisy-chained between all three controllers, per table.

A DMX cable runs from the MacBook Air to the valve table and connects to the first controller board. After that, the DMX cable jumps from one controller to the next.

Each controller has a unique ID set via a five position DIP switch.

If you need to change a board, please also set the DIP switch according to the old controller.

One valve does not move.

Disconnect both sets of white cables that connect the problem valve to the controller board. We left a few empty channels on the controller boards, so try to plug the white cables into a free solenoid channel. You can rearrange where which valve plugs in to, if needed. It is important to remember to first turn the main power off before unplugging anything, otherwise the controller will be damaged.

Each valve has two solenoid coils. Each coil has two white wires. This means that we have four white wires and two connectors per valve. It is important that these wire pairs stay together. If you need to replug a valve into a new channel, both wire pairs must be replugged together.

It is also important to plug the solenoid coils of each valve into the correct side of the PCB, since the vacuum coil is provided with an extra power boost at times.

Troubleshooting Assistance

Prior to contacting the Antimodular Studio with a problem about your artwork, please ensure that you went through the preliminary troubleshooting steps outlined in the previous section.

The troubleshooting process will vary depending on the problem. In order to make the process easier, it is recommended that you collect and send the following information to the studio:

- Date and time when the problem first happened;
- Description of the problem;
- Actions taken so far and conclusions;
- Detailed photographs (or videos) displaying the problem;
- Detailed photographs (or videos) of the suspected faulty component;
- Detailed photographs (or videos) of the whole artwork and its surroundings;
- Personnel involved.

Support (Contact Us)

If you would like support for the piece, please feel free to call Lozano-Hemmer's studio in Canada:

Antimodular Research
4060 St-Laurent, studio 107
Montréal Québec H2W 1Y9 Canada
Tel 1-514-597-0917
Fax 1-514-597-2092
info@antimodular.com
www.antimodular.com

APPENDIX I - INSTALLATION

Description of Components

This artwork requires the following components:



MacBook Air

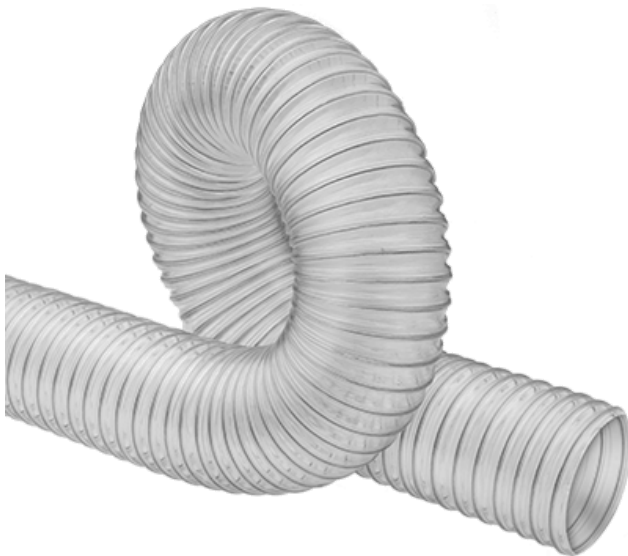

ID	4"
OD	4 1/4"
Flexibility	Very Flexible
Bend Radius	1"
Compresses To	35%
Maximum Vacuum	10 in. of Hg @ 72° F
Maximum Pressure	13 psi @ 72° F
Temperature Range	-20° to 180° F
Material	PVC
Material Thickness	0.015"
Interior Surface Texture	Ribbed
End Type	Unfinished
Color	Clear
Spiral	
Direction	Left Hand
Material	Metal
Compatible Clamps	Worm-Drive Clamps
Wear Strip Included	Without Wear Strip
Environment	Outdoor
Maximum Continuous Length	25 ft.

Transparent, Very Flexible PVC Duct Hose for Dust, 4" ID, 4-1/4" OD



Enttec DMX USB Pro SKU: 70304

Medical air hoses, dispomed.com, part #940-F22108INSS02

Dedicated Wifi router for motion-sensor communication



Honeywell motion sensors (DT6360STC, DT6100STC)
+ custom Wifi microcontroller with OSC communication

Glass (from www.vitreco.ca)

Plastic between glass

White bellow. TODO supplier + drawing (www.marktech.ca)



SSG4000 UltraGlaze Sealant, black

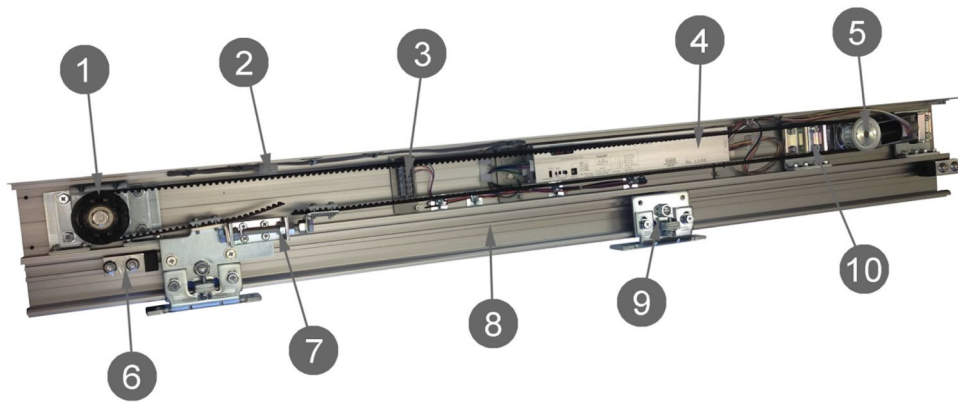

EDM 30NII Operator

1. Idel pulley
2. Tooth belt
3. Connection terminal
4. Control box
5. Motor gear box
6. End stopper
7. Belt tightening bracket

Automatic Sliding Door Operator mechanism from China, T-1500

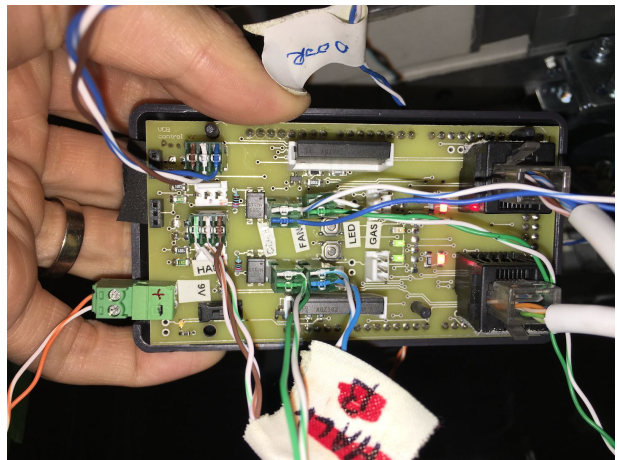
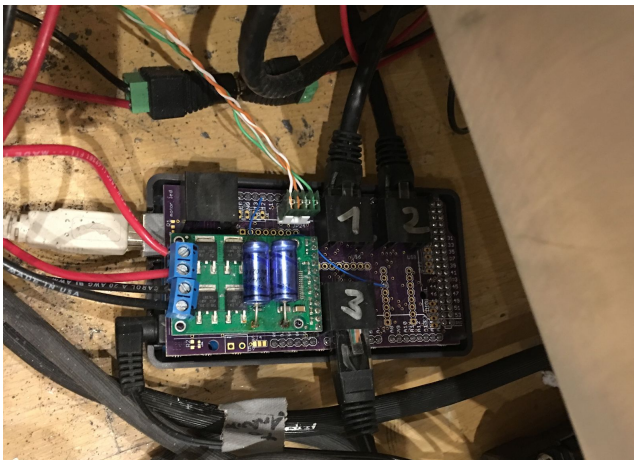

One Arduino Mega to control bellow and a second to control doors.

Custom AC fans with flap



PowerSwitch Tail II Normally Open, AC relays to switch fans

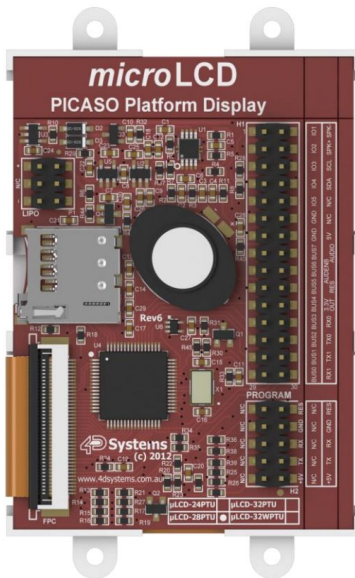

4D Systems 240 x 320 pixel TFT-LCD Display + touch (part #: uLCD-28PTU)

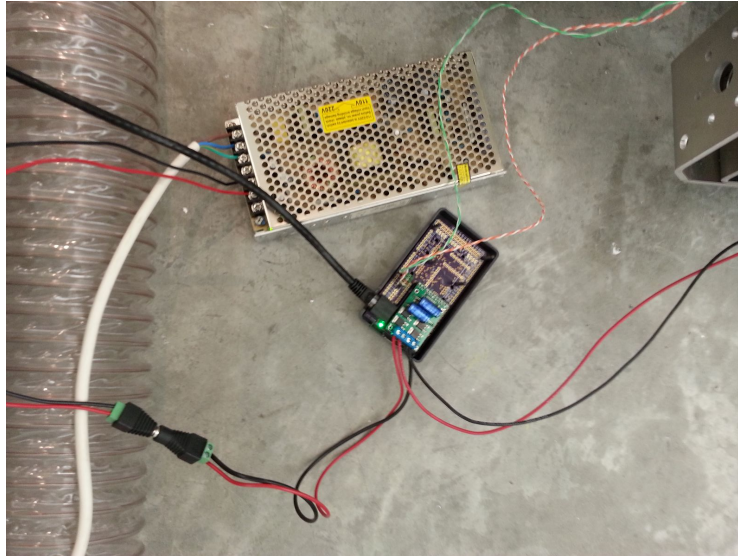

Bellow motor driver + 24 VDC power supply



TECHNICAL SPECIFICATIONS:

- Rated torque: 53 in-lb
- Stall torque: 177 in-lb
- Unload high speed: 50rpm, 1.5A (12VDC)
- Unload low speed: 35rpm, 1.0A (12VDC)
- Maximum wattage: 50W/12VDC
- Motor noise: <45dB
- Spindle/Post thread size: M-6
- Spindle rotates 360 degrees
- Motor weight: 2.7 lbs
- Approx size: 7.25"x4"x3.5"

12VDC car windshield wiper motor (from www.monsterguts.com, product ID: 17685)



Motor DC connectors, 4.75mm Quick Connect Female 14-16 AWG (part # 3-350816-2)

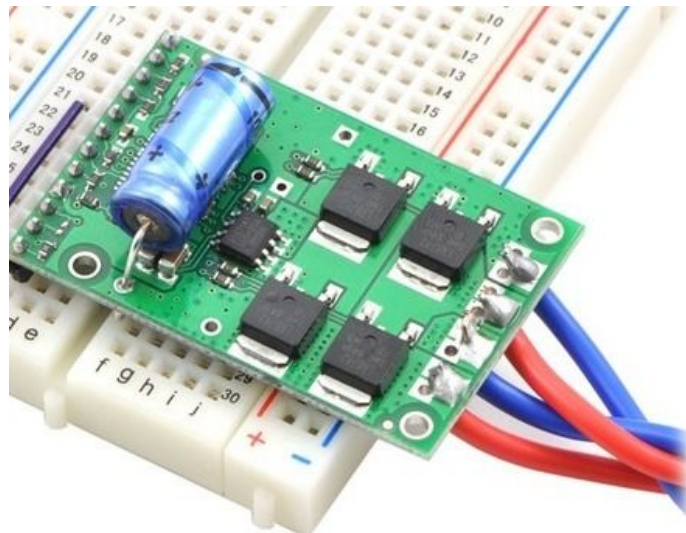

Pololu High-Power Motor Driver 18v25 CS, use to drive the 12VDC wiper motors.
One driver for two motors.



White nylon thread to hang air hoses from ceiling



Cotton string to tie the bags to the hose



Unaltered bag

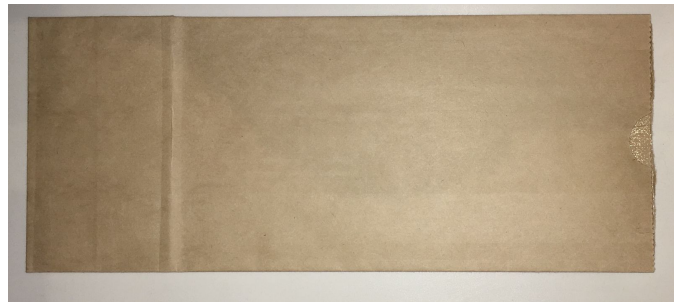

Bag with tie-up removed

Paper Bags (www.enkapack.com, APGS2P13-TN)

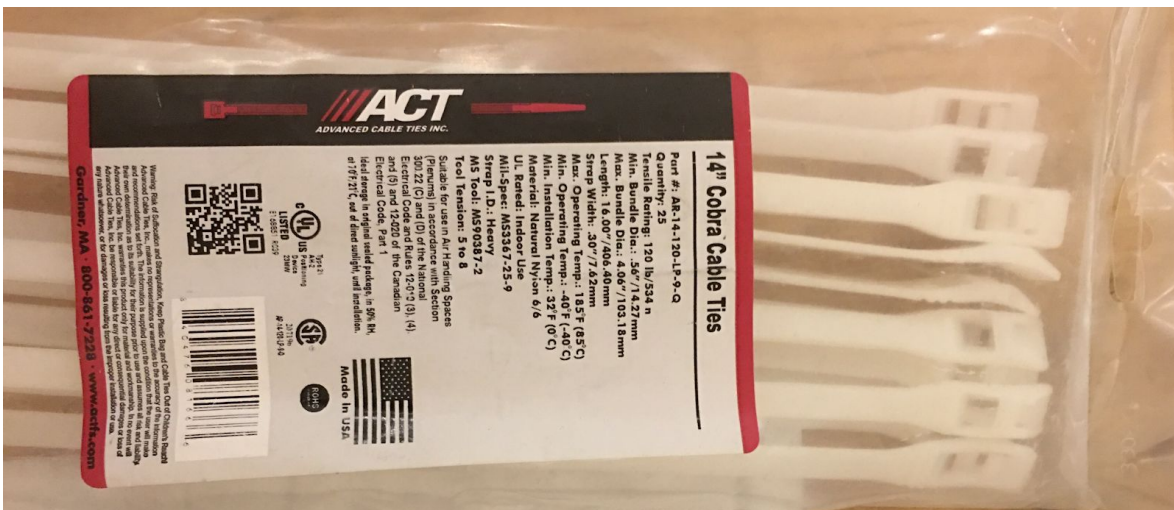

White zip ties to hold air hose to valves, 14" Cobra Cable Ties (part #: AR-14-120-LP-9-Q)



Removable Sealant to seal the non-structural gaps in the glass chamber

Wiring Diagrams and Connections

In order for the piece to run properly, the computer should be connected according to the following diagrams.

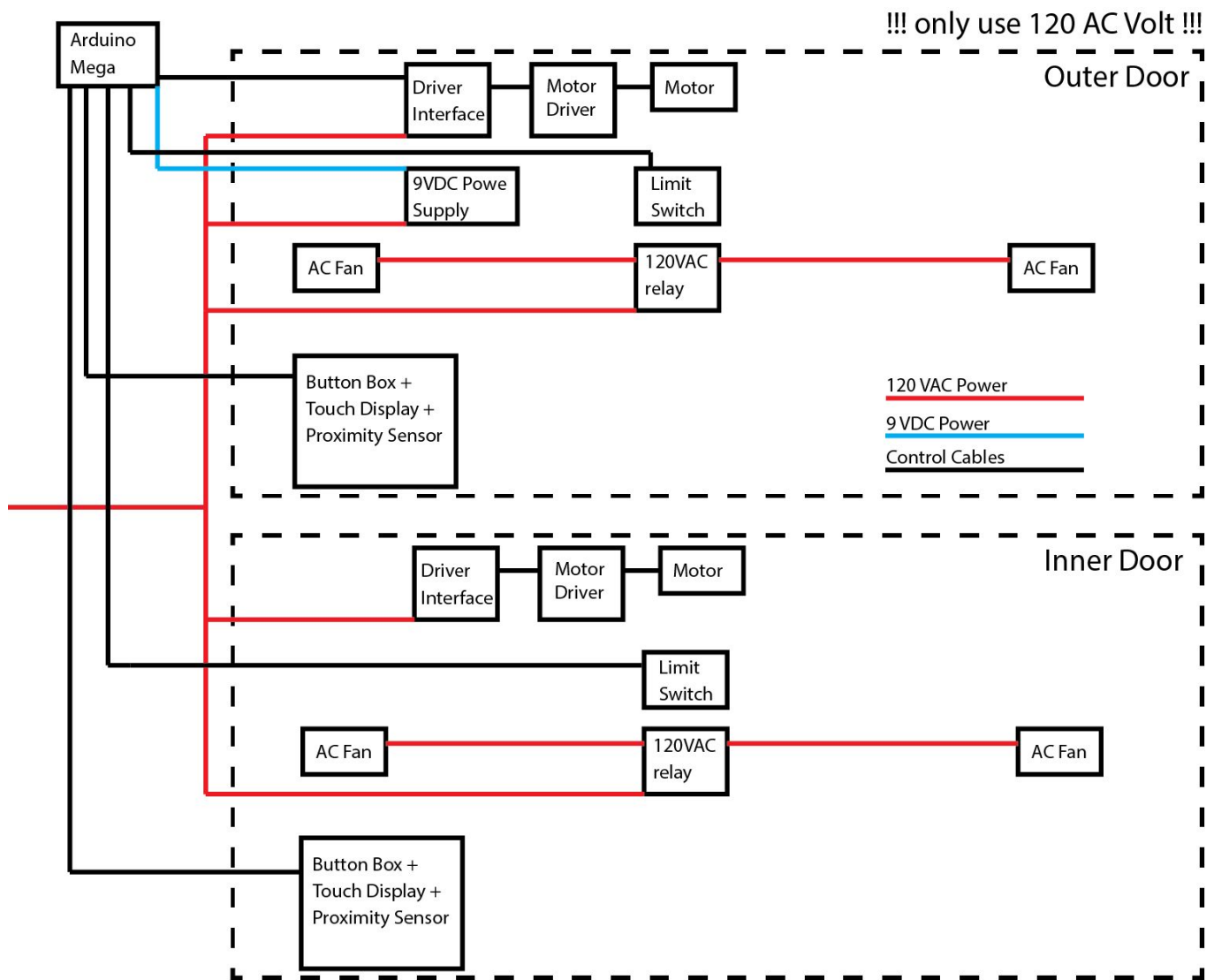

Glass chamber wiring

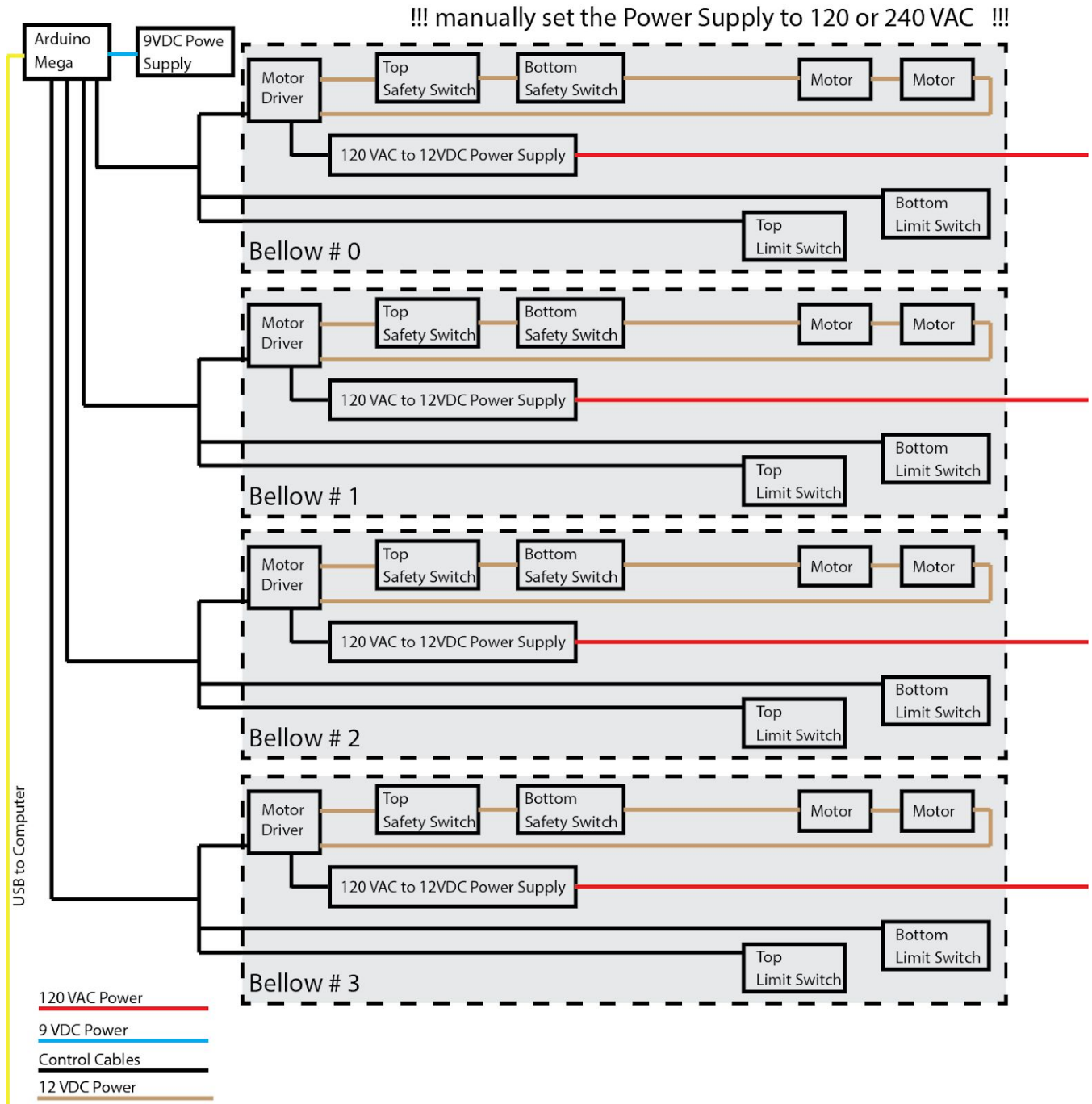

Bellow wiring

Safety and Limit Switch Functions on the Bellows:

The limit switches are located on the left, inside the actuator track. They have thinner wires connected to them. These switches tell the Arduino when the bellow has reached the top or the bottom. In return, the Arduino tells the motor driver to reverse the motor's motion.

The safety switches are located even closer to the absolute limits of the belt drive. If the limit switches do not work and the motor does not reverse direct, then the safety switches might be activated. If this happens, the safety switch will cut the 12VDC power to the motors. You will need to manually move the bellow actuators back until the safety switch is not engaged anymore.

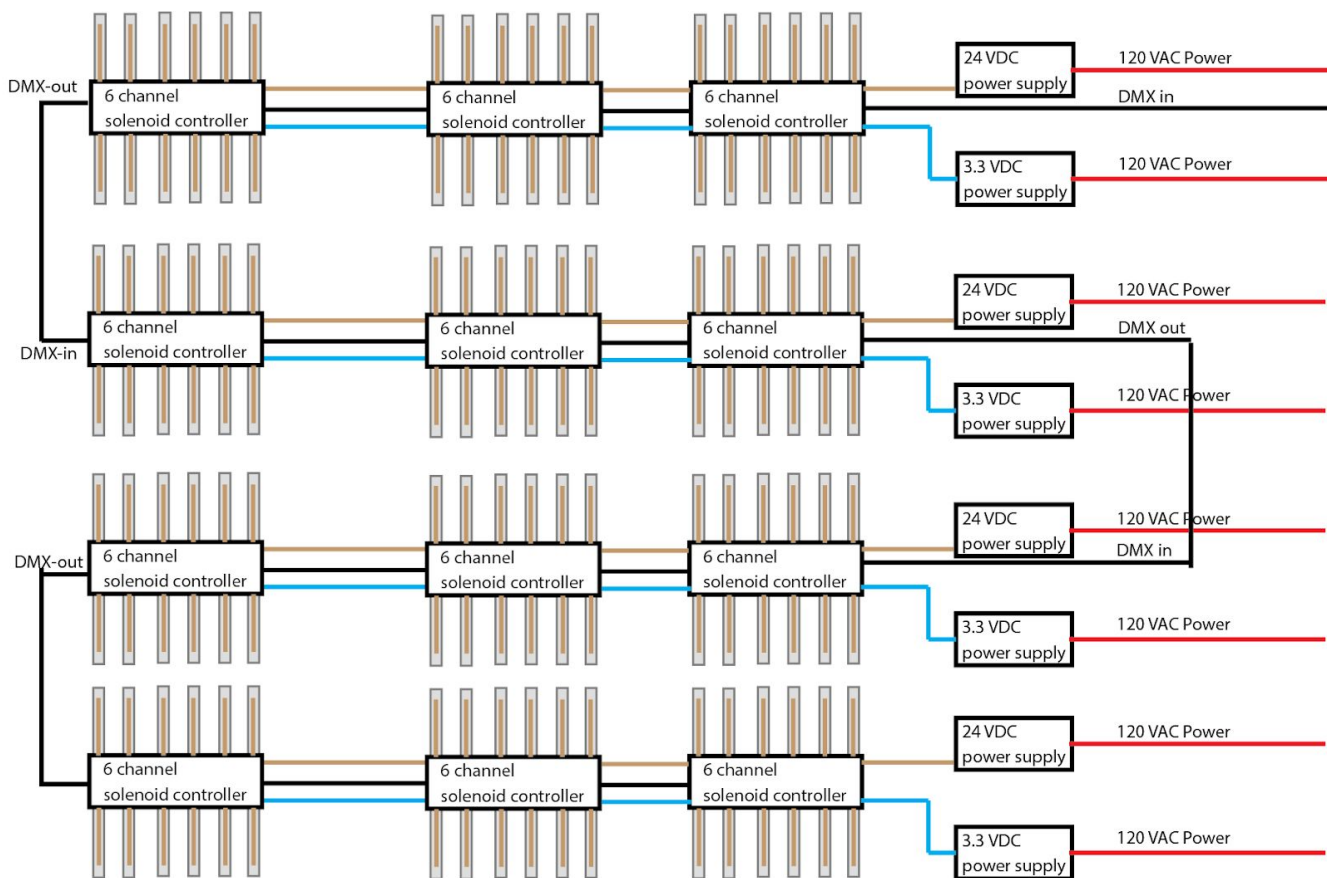

Bellow wiring

Close-Up Photos



Vacuum bellow weights on the carrier plate.



Positive pressure bellow without weights and without carrier plate.

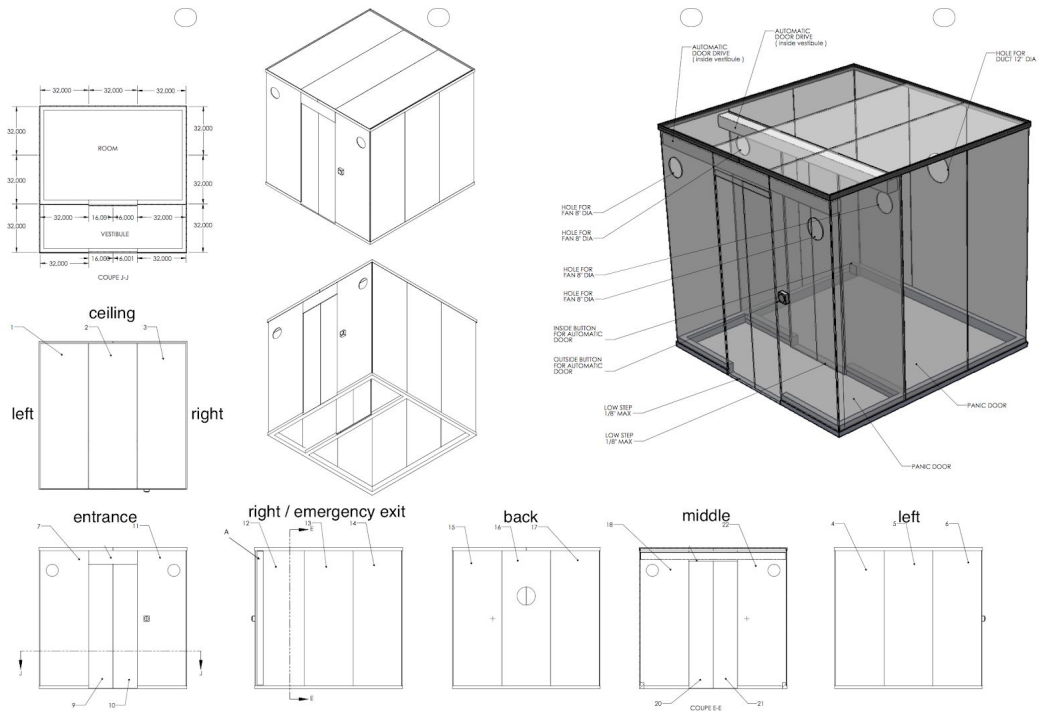

Glass Chamber; Sheet Numbering

Glass Chamber Install Notes:

VCB

GLASS ROOM / DISASSEMBLY STEPS.



- 1) TAKE OF SLIDING DOORS - 2 MAN / 2 LADDER
- A - UNSCREW THE BOLTS THAT HOLD SLIDING DOOR. 9/16" KEY (BRING)
 - B - UNSCREW ONE "CARRIER" FROM THE BEET ~~AND~~ SO YOU CAN FREELY MOVE THE DOOR CENTER.
 - C - REMOVE SLIDING DOORS. PHILIPS SCREW DRIVER

- 2) REMOVING PAINT DOORS / 2 MEN / 2 LADDER.
- A - REMOVE STAINLESS CAPING. PIN.
 - B - REMOVE SOCKET SCREWS FROM TOP HINGE
 - C - BEFORE → SHIM (ALLEN KEY 5MM) CORNER OF THE DOOR WITH WOOD.
 - D - TAKE OUT OF THE BOTTOM ~~HINGE~~ BY LIFTING PIN

- 3) ROOF PANELS. 3 MEN / 3 LADDERS
- A - ~~PUT~~ ~~MOVE~~ "SET BLOC" ON SIDE OF GLASS AND (SO THERE IS NO SHOCKS).
 - B - SLIDE THE FIRST ~~GLASS~~ GLASS
 - C - PUT MASKING TAPE ON THE EDGE OF FRAME. X3

- 4) REMOVE Z-TRACK (AUTOMATIC DOOR)
- A - IDENTIFY
 - B - REMOVE SILICONE SCREW FIRST 1+2 REMOVE CENTER SCREWS THEN 3+4+5 BOTTOM FRAME.
- 5) TAKE OFF ALL RUBBER STRIPS FROM TOP FRAME.

2) ~~A~~ → REMOVING PAINT DOORS / 2 MEN / 2 LADDERS

- A - REMOVE STAINLESS ^{HINGE} CAPING.  PIN.
- B - REMOVE SOCKET SCREWS FROM TOP HINGE 
- C -  BEFORE → STRIKE CORNER OF THE DOOR WITH WOOD (AWREN KEY 5MM)
- D - TAKE OUT OF THE BOTTOM ~~HINGE~~ _{PIN} BY LIFTING.

3) → ROOF PANELS. 3 MEN / 3 LADDERS

- A - ~~PUT~~ ~~MOVE~~ 'SET BLOC' ON SIDE OF GLASS AND (SO THERE IS NO SHOCKS.) 
- B - SLIDE THE FIRST ~~GLASS~~ GLASS
- C - PUT MASKING TAPE ON THE EDGE OF FRAME.  (X3)

4) → REMOVE Z TRACK (AUTOMATIC DOOR)

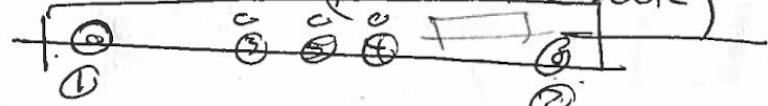
- A -  IDENTIFY
- B - REMOVE SILICONE SCREW FIRST 1+2
- C - REMOVE CENTER SCREWS THEN ^{SILICONE} _{FRAME}

5) → REMOVE 2 CENTER GLASS

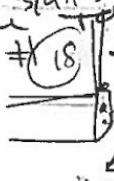
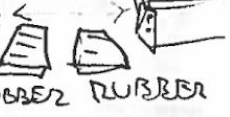
- A - REMOVE BASE EXTRUSION CAP. 
- B - SLIDE GLASS TO CENTER
- C - REMOVE GLASS. 

6) 5,5 → REMOVE THE GLASS STRIPE (NARROW) CUTTING SILICONE

- A - BRASE THE REAR RIGHT CORNER OF THE TOP FRAME

7) → REMOVE FRONT CENTER (#16) GLASS

- B - LIFT THE TOP FRAME AND REMOVE GLASS.

Procedure to Install and Hang the Bags and the Air Hoses

1. Stretch all the medical air hoses and leave them aside. Most hoses are the same length except for 10 of them, which are shorter.
2. Make sure to have 61 black PVC short tubes (joints) which have insulating foam tape glued on one end. Using only long hoses, plug in the joints using the sides that don't have tape on them.
3. The paper bags need to be unfolded before they are wrapped to the top. To do this, stick your hand in the bag to open it up and then wrap your other hand around the top of the bag and use wrist to grasp the paper about four centimetres below the edge of the bag. This will give it a bit of shape before it is attached to the joint.
4. To wrap the bags, use 53 cm of the cotton twine provided to attach the bags to a PVC joint just above the black foam (the tape will prevent the air from leaking.) Wrap it around four times and tie it up with a double knot making sure it is completely tight and the thread doesn't move. This is very important as this will prevent any air leakage once the piece is working. You should have 61 bags attached in total.
5. Once each bag is attached, you must manually double-check whether there is air leakage or not. To do so, take a clean regular PVC joint and insert it into the other side of the hose. Using your mouth, blow and suck air through the hose a couple of times to make sure the bag is properly sealed. If there is any air leakage, please proceed to re-wrap the bag until the problem is solved. Once all the bags have been checked, carefully put them aside onto a clean surface.
6. Take the manifold disk and insert in each hole a clear short PVC joint.
7. Take the long medical air hoses that do not have bags attached to them and plug them in, one by one, on each end of the PVC joints. It is better to plug in both hoses on either side of the joint at the same time. Start from bottom to top. Once the two hoses are plugged in, make sure the PVC join remains in the middle of the manifold and that there is an equal distance of join inserted in each hose.
8. Hang the manifold and put it in place.
9. On the side of the manifold, where paper bags will be attached, plug in the rest of the short PVC joints to all the ends of the hoses. On the other side, plug in all joints directly to the valve table making sure that the hoses coming from the bottom of the manifold are plugged into the the lower level valves, the middle ones to the middle level, and so on.
10. **To hang the bags:** Make sure the hooks that are being used are white. If not, use spray paint to paint them white.
11. Attach about 3,30 m of fishing wire to each hook. To do this, use two long tables and make sure to put a black fabric underneath so you will be able to see the translucent threads. Make a loop and attach it to the hook. Tape the end of the thread with painters tape so that the threads won't get tangled. Prepare as many as possible in advance. Once the

hoses are being hung, these hooks with threads will be used quite fast so it would be ideal to have one person who can focus on this task to continuously replace them.

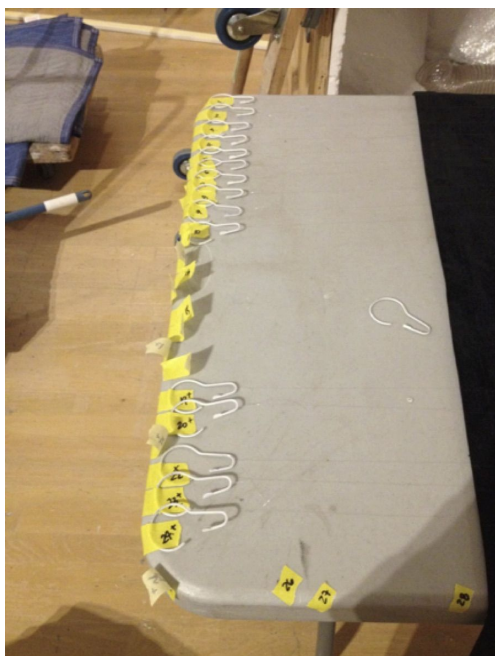

12. Before you start hanging the bags, make sure to hang about 30 loose hooks randomly with threads on the centre of the grid structure located on the ceiling. Hang these hooks closer to the manifold and let them hang freely for later use. Put a piece of coloured painters tape on the end of the threads to find them easily later. These threads will be very helpful to hang the hoses when the genie lift won't be able to reach the centre of the grid anymore and you'll have to do it yourself.
13. The two first hoses with bags that should be hung are the two farthest bags, in the left and right corners, which will indicate how far out the hanging area is going to be. These two bags will also mark the height of the rest of the installation. Height should be between 1,80 m to 2 m from the floor to the bottom of the paper bag.
14. Hang and connect the hoses to the bags to the hoses from the manifold as you go. Do NOT connect all the hoses and then try to hang them. This will prevent the bags from getting damaged and tangled. The final length of tubing is created by connecting two hoses together with a PVC joint. You can make a few tubes longer by connecting an extra short air hose to the previous two. You most likely would only need no more than 3-4 three extension-length tubes in total.
15. Always hang the hoses starting from the centre of the piece outwards, towards the peripheries.
16. When hanging the hoses and when passing the fishing wire around the hose on the hanging point, do not close the knot completely. Instead, make a slipped knot until all the height adjustments made after all the hoses have been hung are complete. (Such as the knot pictured below.)

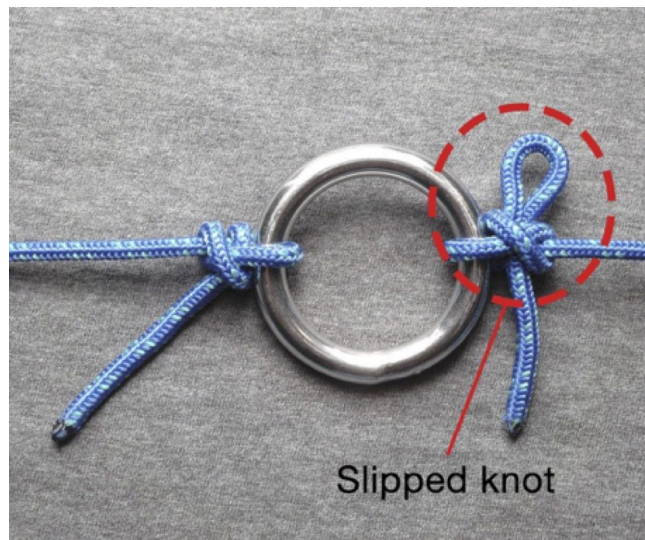

17. Once all the bags are hung, make the height necessary adjustments by using a step ladder.

18. Once the adjustments are made, close all the fishing wire knots and cut the remaining thread about half a centimetre from the knot.

Special Notes:

The hanging process typically requires five people and two genie lifts; one person on each genie lift (two people in total), two people directing the installation by passing the hooks and air hoses (one on each), and one person preparing the hooks with fishing wire.

Never pass more than two ready-to-use hooks to the people on the lifts. The threads will get tangled and it will end up in a big mess.

For reference, installing all the bags with the help of a lift takes about two 8-hour work days.